

Data Sheet



Article number: 03449050

Description: Fluro Heavy Duty Spherical Plain Bearing GE 50 SWE
Hole Ø50

Note: 50

Measures

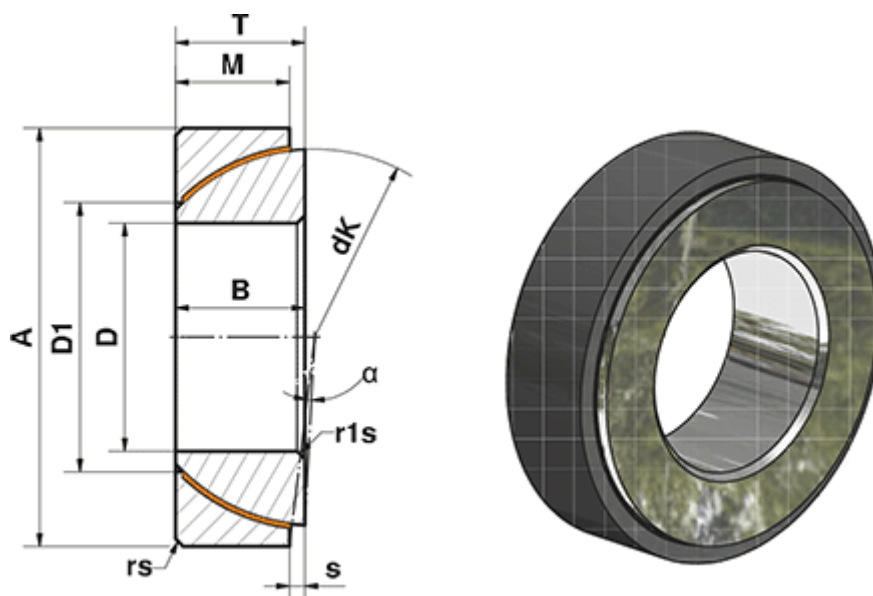

A	= 80	rs, r1s min	= 1
a (degrees)	= 1.5	S	= 4.3
B	= 20	Static load C0 (kN)	= 567
D	= 50	T	= 20
D1	= 59.7	Weight (g)	= 455
dK	= 74		
Dynamic load C (kN)	= 340		
M	= 19		